

Book 3

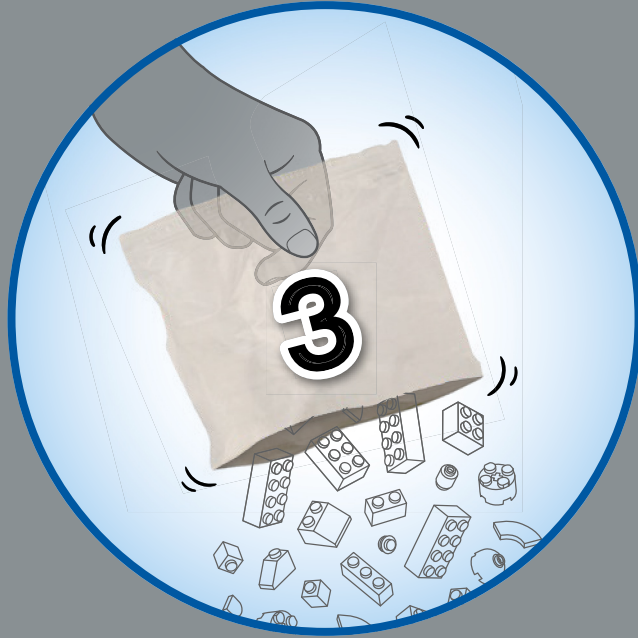

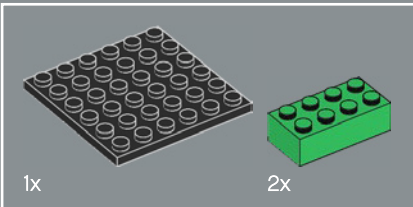



1

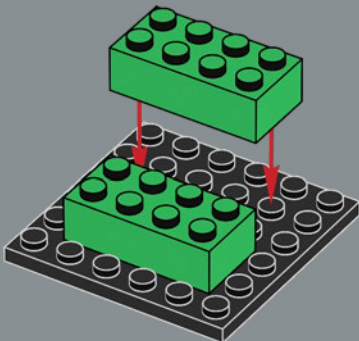

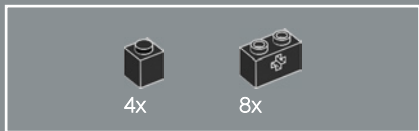

2

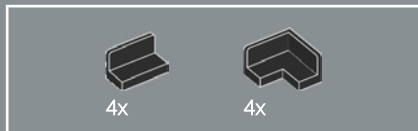
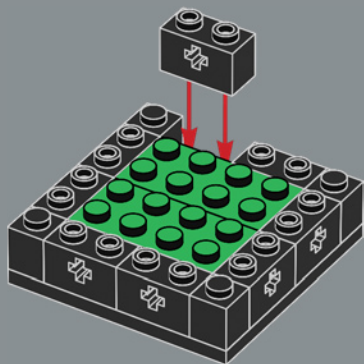

3

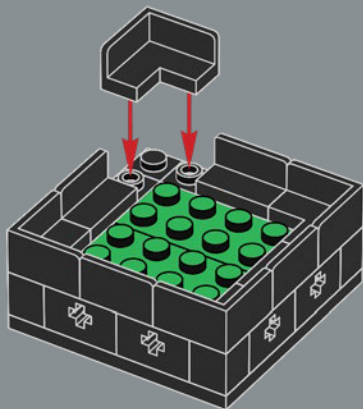

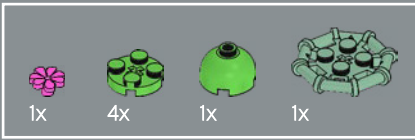

4

1

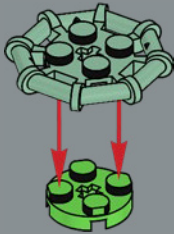

2

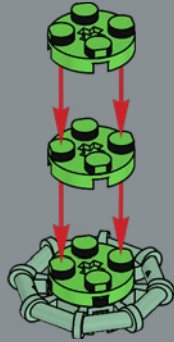

3

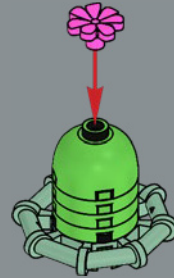

5

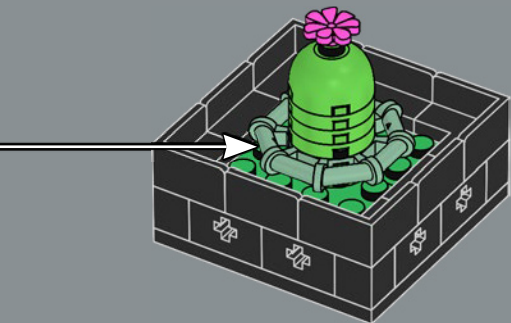

6



6

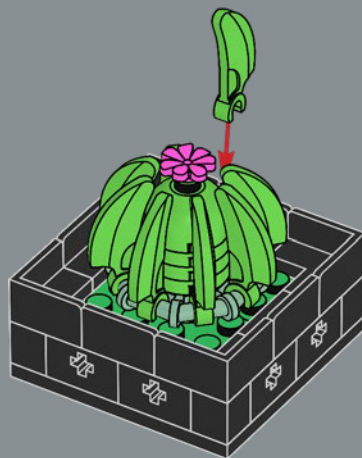

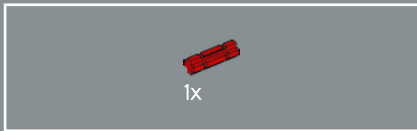

7

Cactus barril
Las cactáceas, incluido el cactus barril, ¡pueden vivir de 10 a 200 años! Y apostamos a que las Suculentas LEGO® podrían batir ese récord.

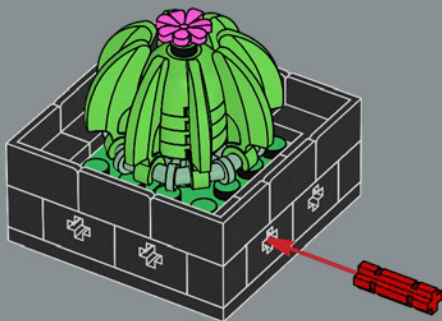

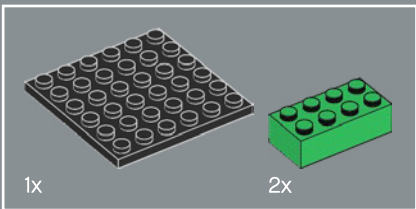
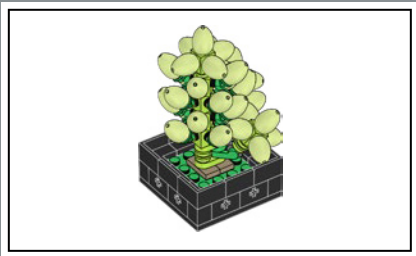

1

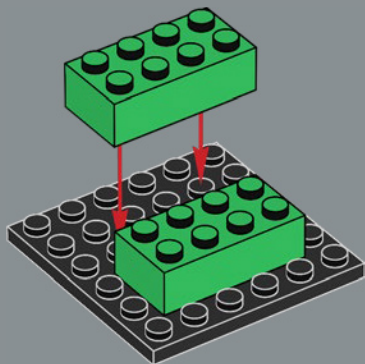

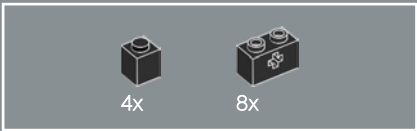

2

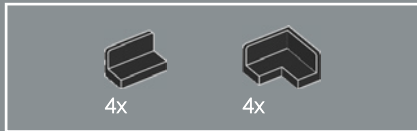
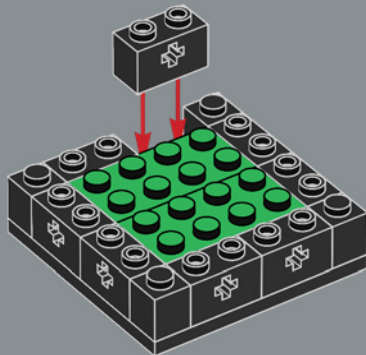

3

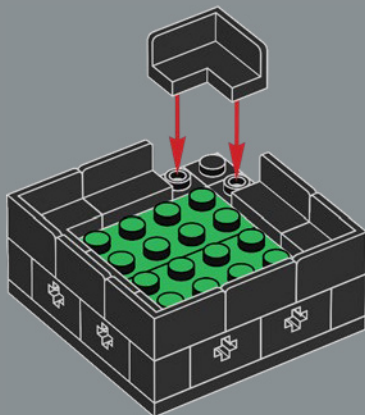

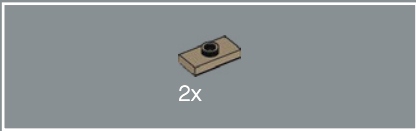

4

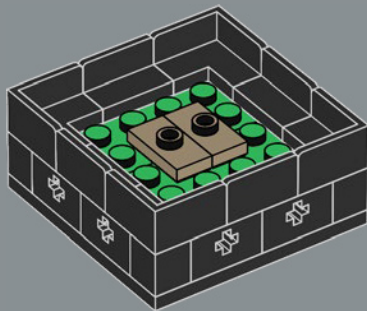



5

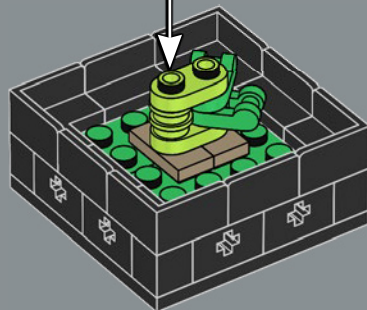
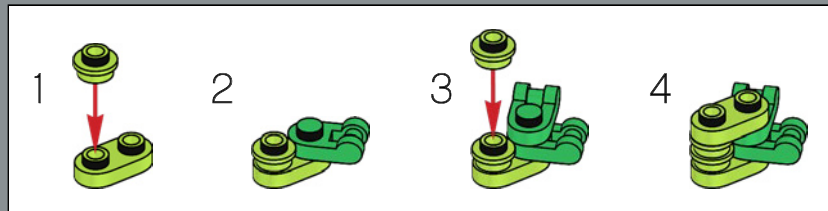



6

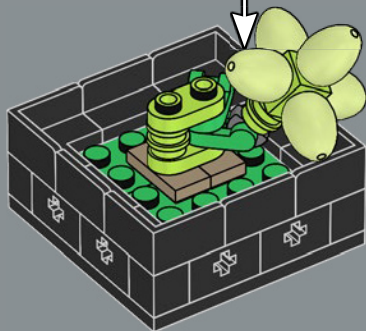
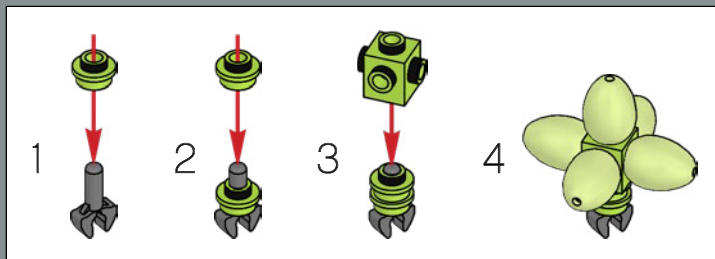

Hojas feroces
Las rechonchas hojas verdes de la planta cola de burro se han recreado con piezas comúnmente usadas para representar huevos de dinosaurio en los sets LEGO®.

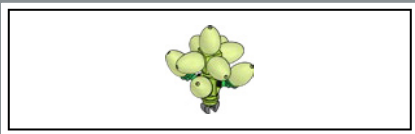

1x

7

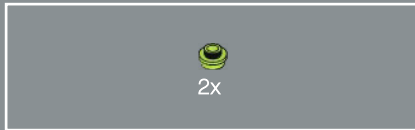

2x

8



1x

1x

9





4x

10



1x

11

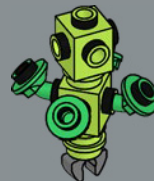



12

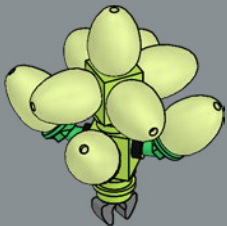

13

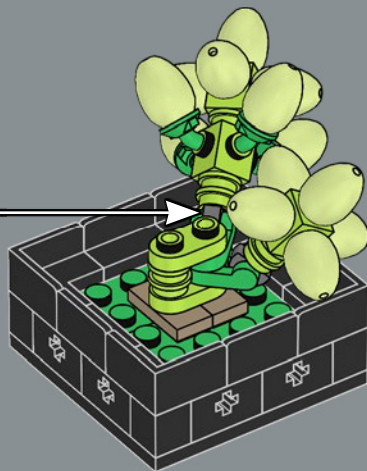

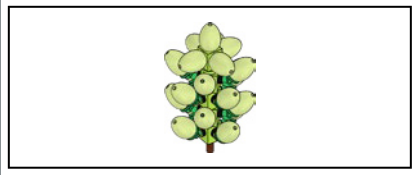

14

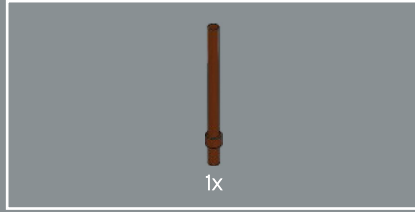
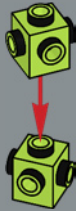

15

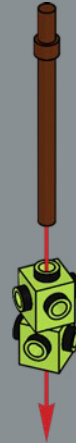

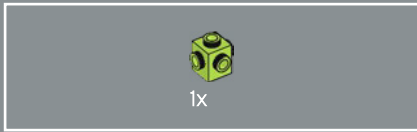

16



17



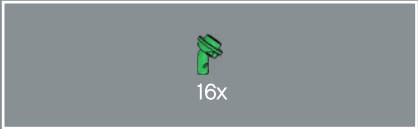

18



19

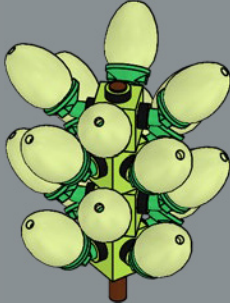



20

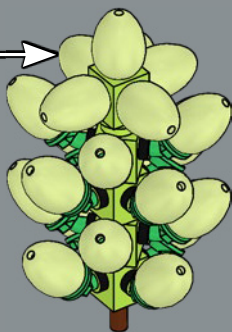
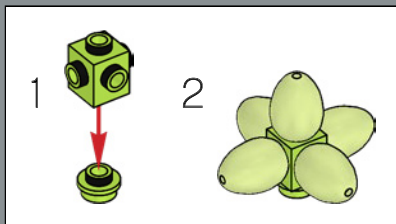

21

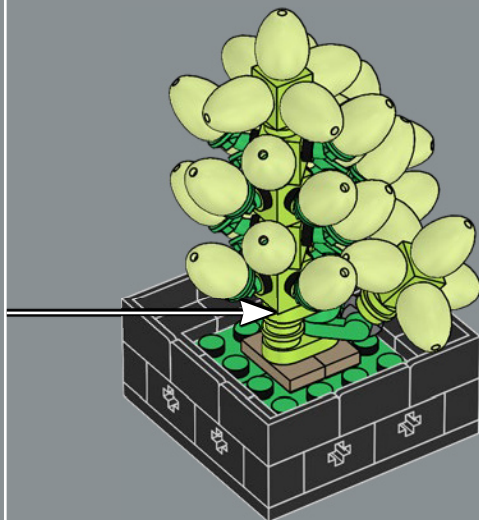

Cola de burro

La cola de burro es una planta tropical originaria de México y Centroamérica.

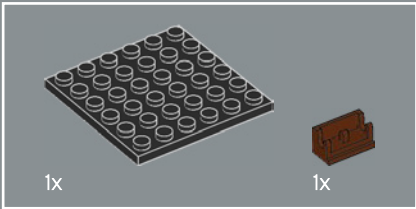
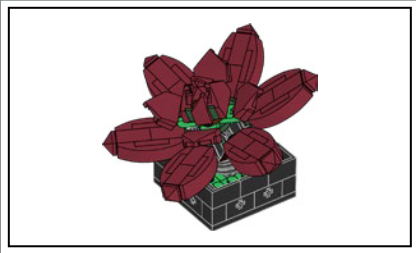

1

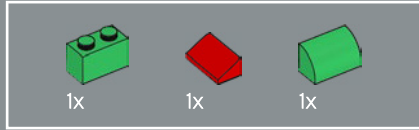
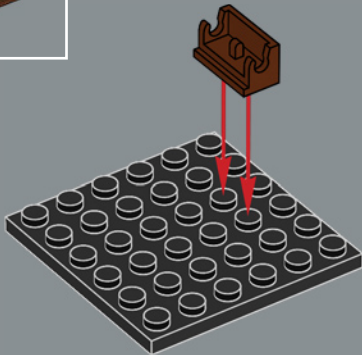

2



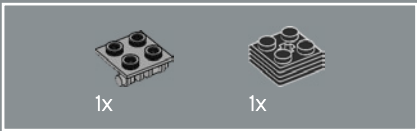

3

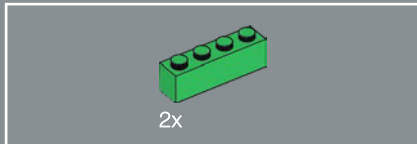
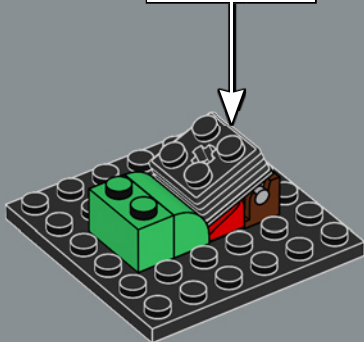
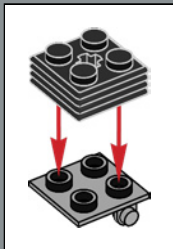

4

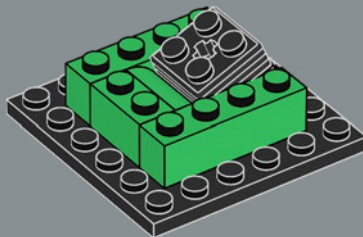

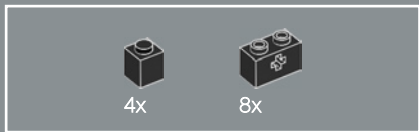

5

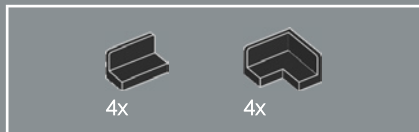
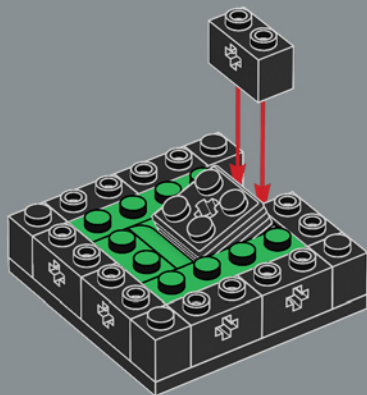

6

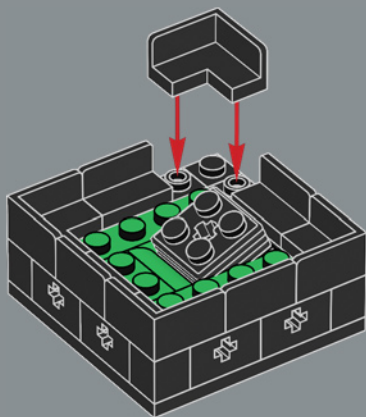

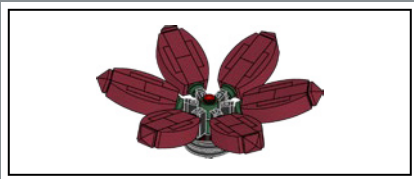

7

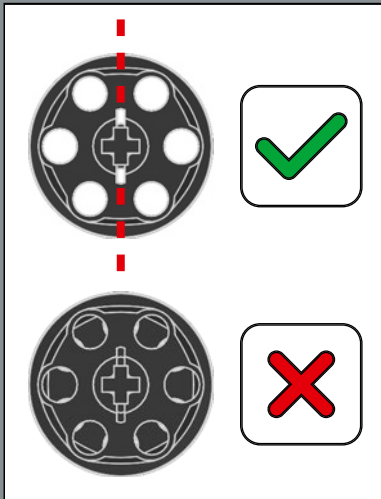
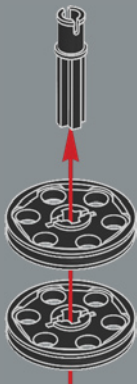

8





9

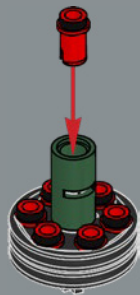

10

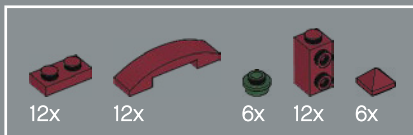

11

1

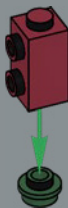

2



3

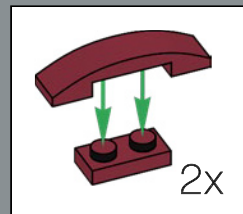

6x

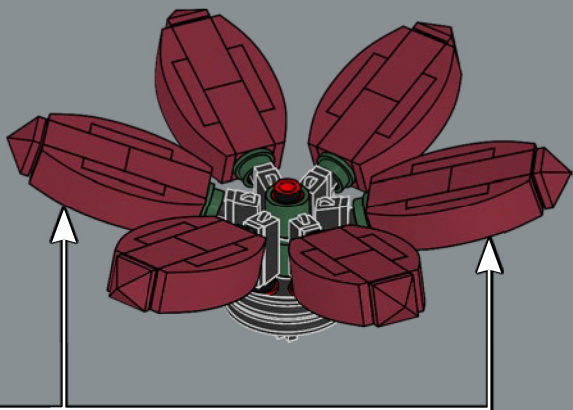

12

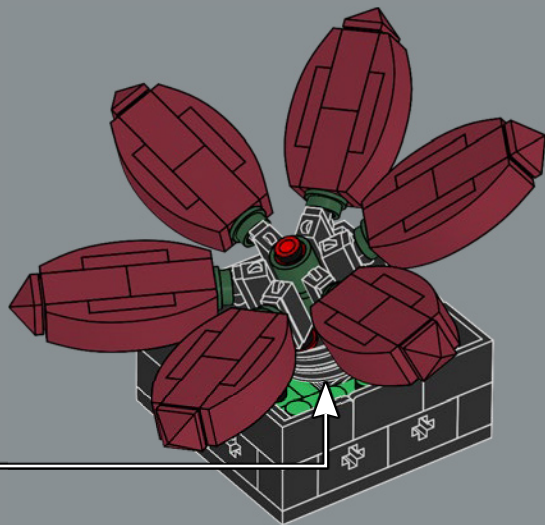

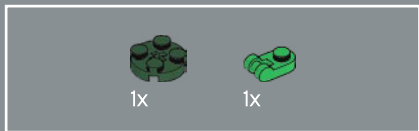

13

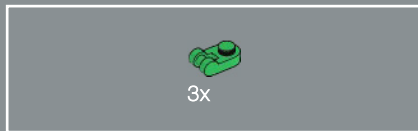
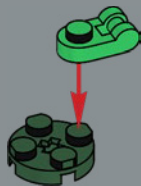

14

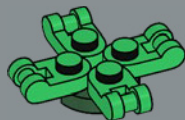

15

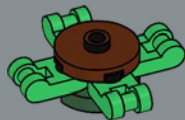

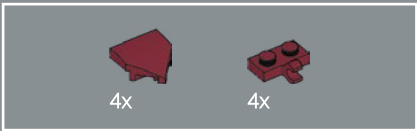

16

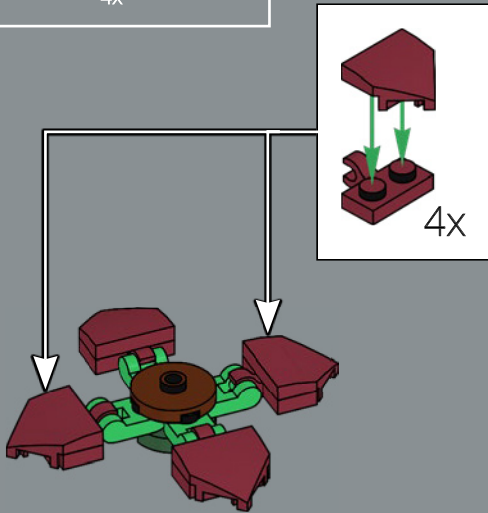

17

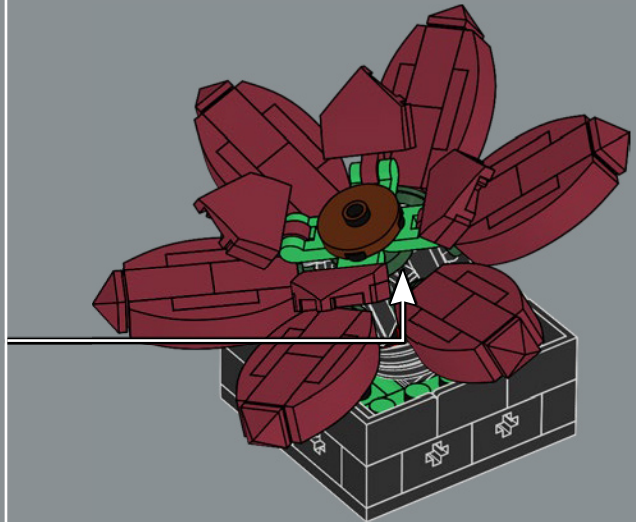

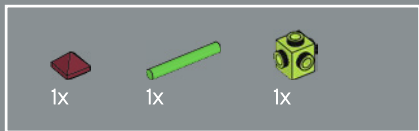

18

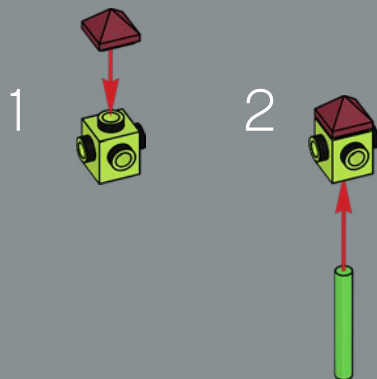

Suculenta con inspiración caballeresca
Las puntas de las hojas de la echeveria roja, con su tonalidad rubí, tienen piezas piramidales creadas originalmente para los sets LEGO® NEXO KNIGHTS™.

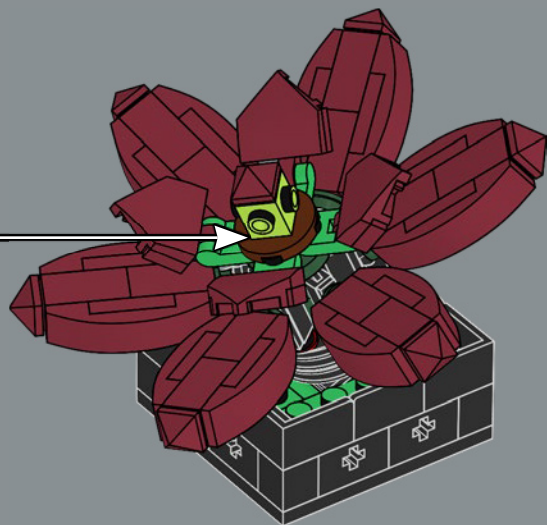

Echeveria roja

El rojo es el color del amor. El próximo Día de San Valentín, ¡olvida las rosas y regala una echeveria roja LEGO® en su lugar!

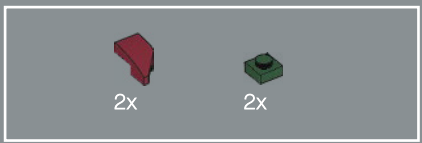

19

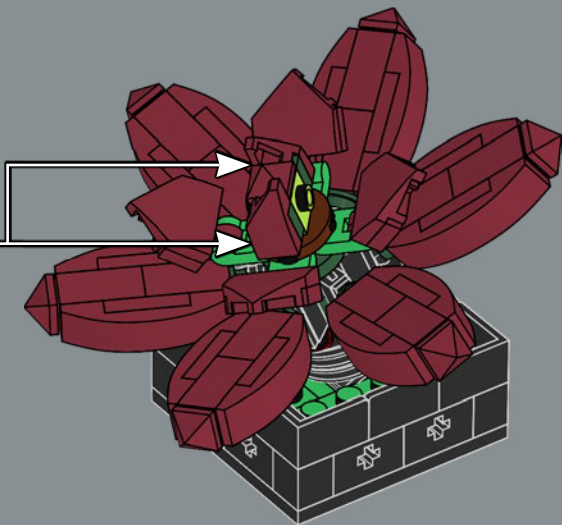
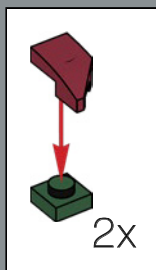



20

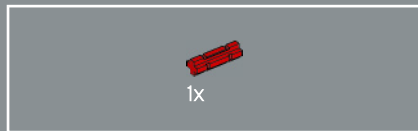
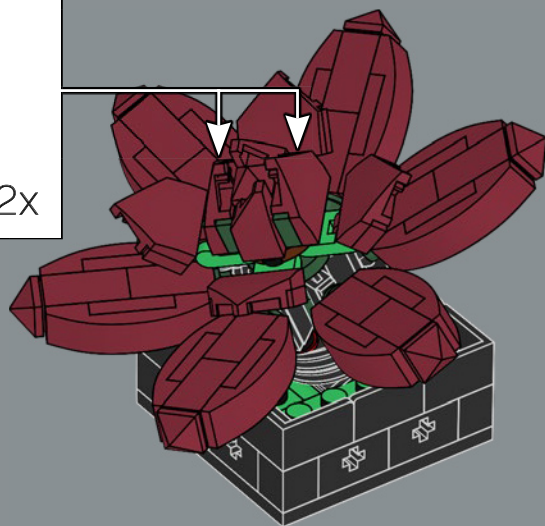
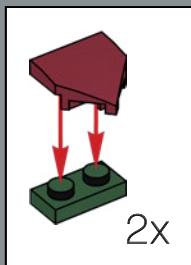

21

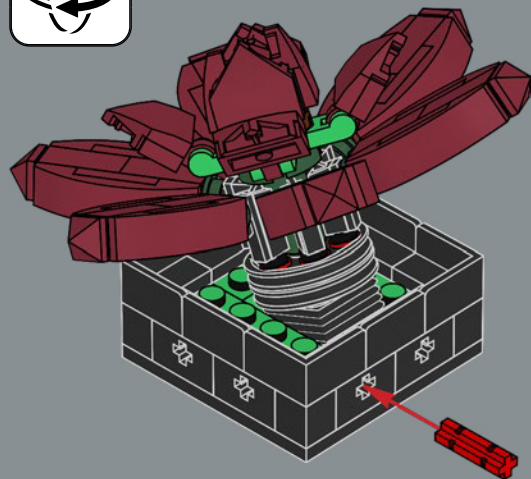

22

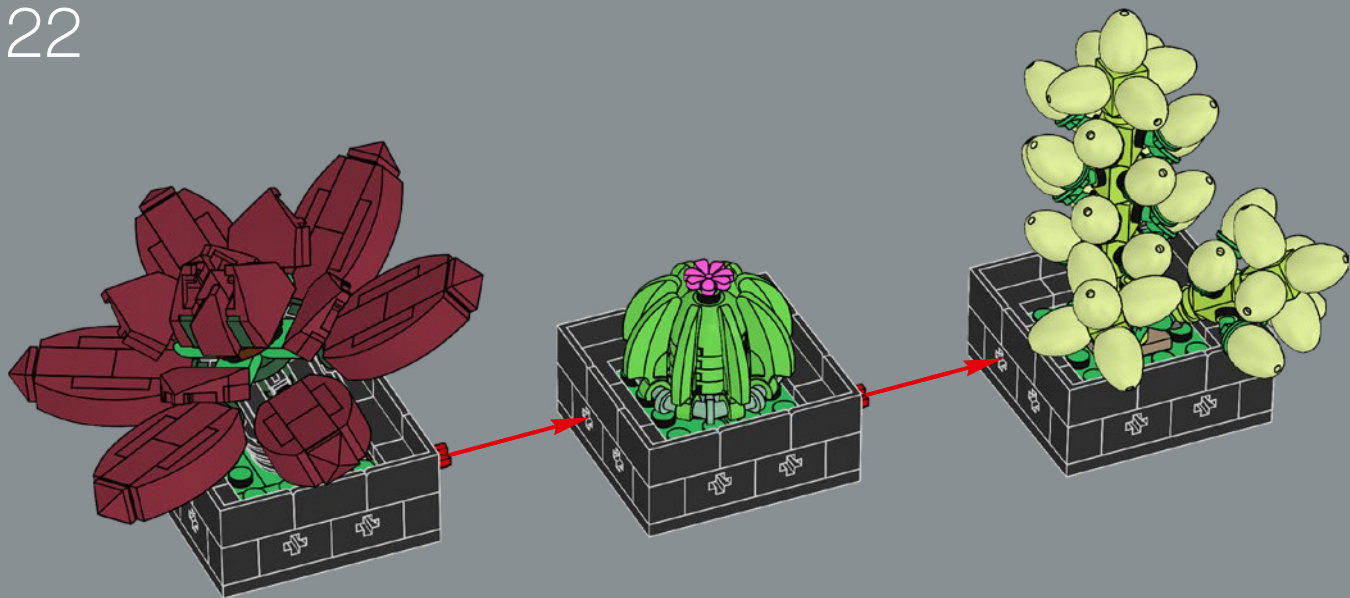

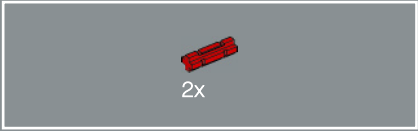

23

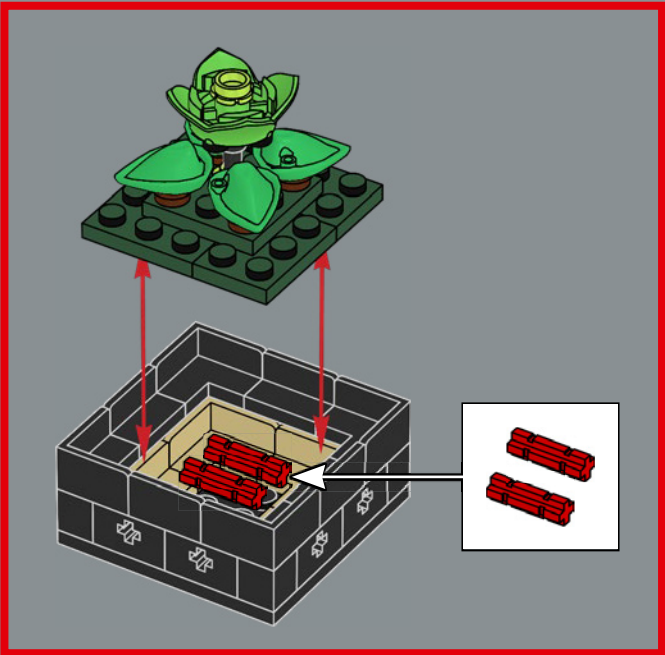

24

